

errebi



INDICE

da pag. 4 - 8 **ARMADI**

PORTAUTENSILI da pag. 9 - 18

da pag. 19 - 21 **BANCHI DA LAVORO**

pag. 22 **CASSETTIERE**

CONTENITORI da pag. 23 - 24

da pag. 25 - 30 **CARRELLI**

SCAFFALATURE pag. 31

pag. 32 **L'AZIENDA**

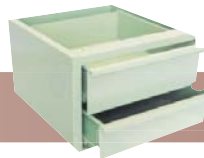



Codice art. C2

con tetto inclinato
Dim. 200Hx80Lx47P

Codice art. C2

su panca
Dim. 205Hx80Lx77P

Optionals applicabili a diversi modelli di nostra produzione: tetto inclinato, struttura panchina costruita con tubo quadro verniciato da 30 mm con listoni in faggio su cui poggia direttamente l'armadio senza piedini.

Codice art. PANCA

Dim. 100Lx35Px45H

Codice art. PANCA

Dim. 200Lx35Px45H

**Codice art. PANCA
con cappelliera**

Dim. 100Lx35Px180H

**Codice art. PANCA
con cappelliera**

Dim. 200Lx35Px180H



Panchina per locale spogliatoio realizzata in tubo quadro di acciaio 30x30 con ripiano portascarpe, verniciata a forno in colore grigio e blu. Seduta con doghe di legno verniciato naturale.



Codice art. PS1

Dim. 180Hx60Lx40P

Internamente 4 ripiani divisibili e spostabili su cremagliera permettono l'utilizzo di questo contenitore in versione portascopie o tuttopiani.

Codice art. B1

Dim. 180Mx38Lx35P

Codice art. F1

Dim. 180Hx38Lx47P

Codice art. B2

Dim. 180Mx70Lx35P

Codice art. F2

Dim. 180Hx70Lx47P

Codice art. B3

Dim. 180Mx102Lx35P

Codice art. F3

Dim. 180Hx102Lx47P



Un ripiano posaogetti in ogni vano, portacartellino di serie.
Dispositivo portaombrelli e antine colorate a richiesta.

**Codice art. B2+2**

Dim. 180Mx70Lx35P

Codice art. B3+3

Dim. 180Mx102Lx35P

Codice art. F2+2

Dim. 180Hx70Lx47P

Codice art. F3+3

Dim. 180Hx102Lx47P

In ogni vano 4 ganci appendiabito e a richiesta un tubo portagruccie.
Metallica o serratura a chiavi. Portacartellino di serie.
Antine colorate a richiesta.

Codice art. B2+2

Dim. 180Mx70Lx35P

Codice art. B3+3

Dim. 180Mx102Lx35P

Codice art. F2+2

Dim. 180Hx70Lx47P

Codice art. F3+3

Dim. 180Hx102Lx47P



Ripiano posaogetti con sottostante separazione per
indumenti puliti e da lavoro a norma D.P.R. 327/80.
Portacartellino di serie.



Codice art. G4

Dim. 200Hx100Lx45P

Codice art. G1

Dim. 180Hx80Lx40P

CB 120

ante scorrevoli

Dim. 2000Hx1200Lx450P

CB 180

Dim. 2000Hx1800Lx450P

Armadio in lamiera spessore 0.7 mm verniciata RAL 7038 ad ante battenti montate su cerniere esterne, chiusure con serratura a duplice espansione, 4 ripiani con portata 80 kg ciascuno, spostabili su cremagliera e predisposti per cartelle sospese.



Codice art. PV60

Dim. 100Hx60Lx45P

Codice art. PV100

Dim. 100Mx100Lx45P

Hobbistica dotati di cassetti scorrevoli su guide di lamiera con separatori per utensili, 2 ripiani spostabili su cremagliera, serratura a duplice espansione.

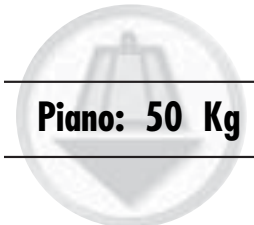

Piano: 50 Kg

ERGO AIR 30

Art. J 46040 08

Ral 7035

Armadio con porte a battente a 4 piani e serratura a cilindro.

Dim. 1000x400x2000 mm h.



Cassetti con CUSCINETTI A SFERA IN ACCIAIO.

**Piano: 50 Kg
Cassetto: 20 Kg**



ERGO AIR 10

Art. J 46041 01

Ral 7000

Armadio con porte a battente e piano a 3 bordi completo di 2 piani e serratura a cilindro.

Dim. 485x500x1000 mm h.

ERGO AIR 11

Art. J 46044 01

Ral 7000

Armadio con porte a battente e piano a 3 bordi completo di 1 cassetto, 1 piano e serratura a cilindro.

Dim. 485x500x1000 mm h.



Piano: 50 Kg

ERGO AIR 20

Art. J 46042 01

Ral 7000

Armadio con porte a battente e piano a 3 bordi completo di 2 piani e serratura a cilindro.

Dim. 980x500x1000 mm h.



Piano: 50 Kg
Cassetto: 20 Kg

ERGO AIR 21

Art. J 46043 01

Ral 7000

Armadio con porte a battente e piano a 3 bordi completo di 1 cassetto, 1 piano e serratura a cilindro.

Dim. 980x500x1000 mm h.

Cassetti con CUSCINETTI A SFERA IN ACCIAIO.



Safety-system
 Impedisce l'apertura
 accidentale dei cassetti.
 Di serie su RED VAN.

**Capacità di
 carico statico
 del carrello**
300 Kg

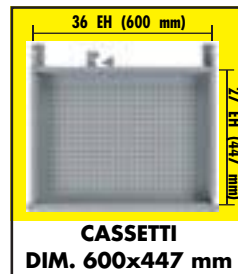

ET: Estrazione totale semplice

RED VAN

Art. **J 45009 BR**

Ral 3020

Ral 7000

Carrello con 3 cassetti **vuoti**, 1 porta
 e chiusura a cilindro con due chiavi.
 Dim. 785x620x885 mm h.



Ruote in gomma
 Ø 100 mm



Le maniglie possono
 essere montate anche
 verso il basso.



Porta basculante.

RED VAN SET 1

Art. **J 45010 00**

Set materiale di separazione per 3 cassetti composto da
 2 divisori fessurati longitudinali e 3 divisori trasversali
 per ogni cassetto.



X 3

RED VAN SET 2

Art. **J 45011 00**

Set materiale di separazione per 3 cassetti composto da
 1 lamina trasversale e 3 pioli per ogni cassetto.



X 3

WORK 2

Art. **J 45008 00**

Piano in legno con 8
 vaschette per RED VAN
 Dim. 717x600x20 mm h.



RED VAN SET 2
 Adatta nei cassetti
 qualsiasi termoformato
 delle maggiori case
 costruttrici di utensili.

PORTAUTENSILI





Capacità di carico statico dell'armadio
500 Kg

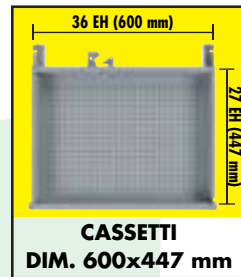

ET: Estrazione totale semplice



RED MASTER

Art. J 45001 BR

Ral 3020

Ral 7000

Armadio con 7 cassetti **vuoti** e chiusura a cilindro con due chiavi.
Dim. 717x600x1000 mm h.

RED MASTER SET 1

Art. J 45002 00

Set materiale di separazione per 6 cassetti composto da 2 divisori fessurati longitudinali e 3 divisori trasversali per ogni cassetto.



X 6

RED MASTER SET 2

Art. J 45003 00

Set materiale di separazione per 6 cassetti composto da 1 lamina trasversale e 3 pioli per 3 cassetti e da 2 divisori fessurati longitudinali e 3 divisori trasversali per gli altri 3 cassetti.



X 3



X 3



RED MASTER SET 2

Adatta nei cassetti qualsiasi termoformato delle maggiori case costruttrici di utensili.



RED WORK 1

Art. J 45004 2Y

Piano 4 bordi con gomma antiolio per RED MASTER.
Dim. 717x600x20 mm h.

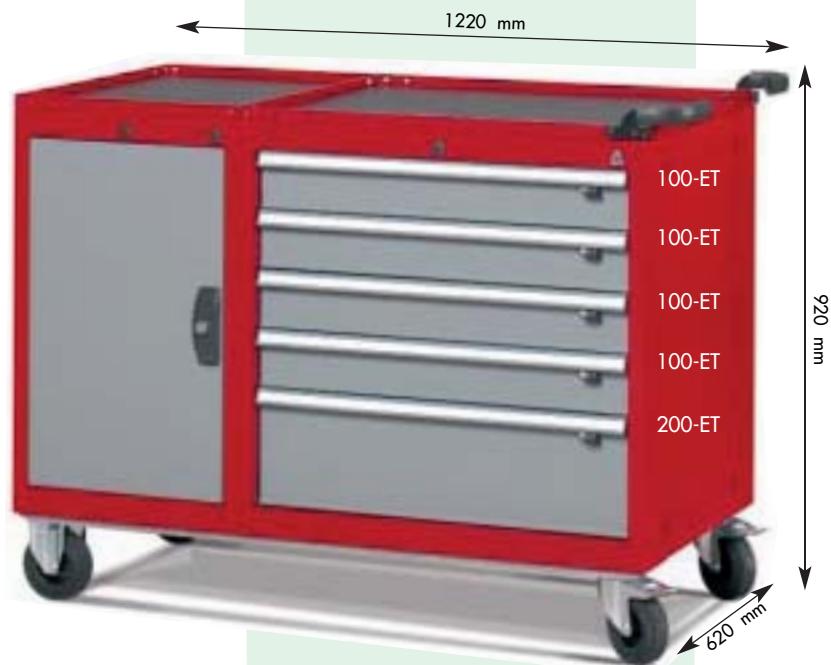

Capacità di
carico statico
del carrello
400 Kg

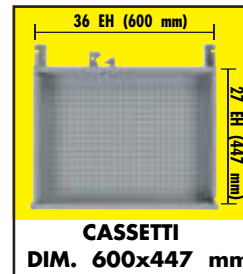

ET: Estrazione totale semplice

RED TRAK

Art. J 45014 BR

Ral 3020

Ral 7000

Carrello con 5 cassetti **vuoti** e chiusura a cilindro con due chiavi, 1 porta con piano regolabile in altezza e chiusura a cilindro con due chiavi. Dim. 1220x620x920 mm h.



Ruote in gomma
Ø 125 mm



Safety-system
Impedisce l'apertura
accidentale dei cassetti.
Di serie su RED TRAK.



Le maniglie possono essere
montate anche verso il basso.



Porta con chiusura a
cilindro e piano regolabile in
altezza.

RED TRAK SET 1

Art. J 45015 00

Set materiale di separazione per 4 cassetti composto da
2 divisori fessurati longitudinali e 3 divisori trasversali
per ogni cassetto.



X 4

RED TRAK SET 2

Art. J 45016 00

Set materiale di separazione per 4 cassetti composto da
1 lamina trasversale e 3 pioli per ogni cassetto.



X 4

RED TRAK SET 2
adatta nei cassetti
qualsiasi termoformato
delle maggiori case
costruttrici di utensili.

WORK 2

Art. J 45008 00

Piano in legno con 8
vaschette per RED TRAK.
Dim. 717x600x20 mm h.





Ruote in gomma
Ø 100 mm



Safety-system

Impedisce l'apertura
accidentale dei cassetti.
Di serie su RED ROL.

**Capacità di
carico statico
del carrello**
300 Kg



ET: Estrazione totale semplice

<p>RED ROL Art. J 45012 BR</p> <p>Carrello con 5 cassetti vuoti e chiusura a cilindro con due chiavi. Dim. 445x675x885 mm h.</p>	Ral 3020
	Ral 7000



<p>RED ROL SET 1</p>	<p>Art. J 45013 00</p>
<p>Set materiale di separazione per 4 cassetti composto da 1 divisorio fessurato longitudinale e 2 divisori trasversali per ogni cassetto.</p>	



Cassette divisorio vedi
pagina **10**.

S: Estrazione semplice



Cassetto h 50: 60 Kg
 Cassetto h 75: 80 Kg
 Cassetto h 100: 100 Kg
 Cassetto h 150: 100 Kg
 Cassetto h 200: 100 Kg

Capacità di carico statico dell'armadio
3000 Kg

CASSETTI DIM. 600x600 mm

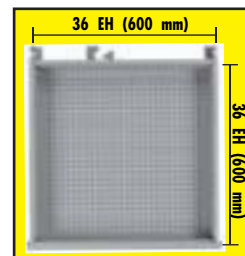

Safety-bar
 Apertura singola dei cassetti che **evita** il ribaltamento dell'armadio.
 Di serie su **TECNO STANDARD**.



TECNO STANDARD 6

Art. **J 14017 04**

Ral 5012

Armadio con 6 cassetti **vuoti** e chiusura a cilindro con due chiavi.
 Dim. 717x726x1000 mm h.

TECNO STANDARD 7

Art. **J 14001 04**

Ral 5012

Armadio con 7 cassetti **vuoti** e chiusura a cilindro con due chiavi.
 Dim. 717x726x1000 mm h.

TECNO STANDARD SET 6 Art. **J 14117 00**

Set materiale di separazione per 6 cassetti composto da 2 divisori fessurati longitudinali e 3 divisori trasversali per ogni cassetto.

120,00



TECNO STANDARD SET 7 Art. **J 14101 00**

Set materiale di separazione per 6 cassetti composto da 2 divisori fessurati longitudinali e 3 divisori trasversali per ogni cassetto.

96,00



TECNO WORK 3

Art. **J 14099 07**

Piano 3 bordi con gomma antiolio per **TECNO STANDAR**.
 Dim. 717x726x20 mm h.



S: Estrazione semplice



Cassetto h 50: 60 Kg
 Cassetto h 75: 80 Kg
 Cassetto h 100: 100 Kg
 Cassetto h 150: 100 Kg
 Cassetto h 200: 100 Kg

Capacità di carico statico dell'armadio
3000 Kg

CASSETTI
 DIM.
 600x600
 mm

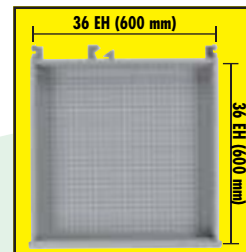

Safety-bar
 Apertura singola dei cassetti che **evita** il ribaltamento dell'armadio.
 Di serie su TECNO STANDARD.

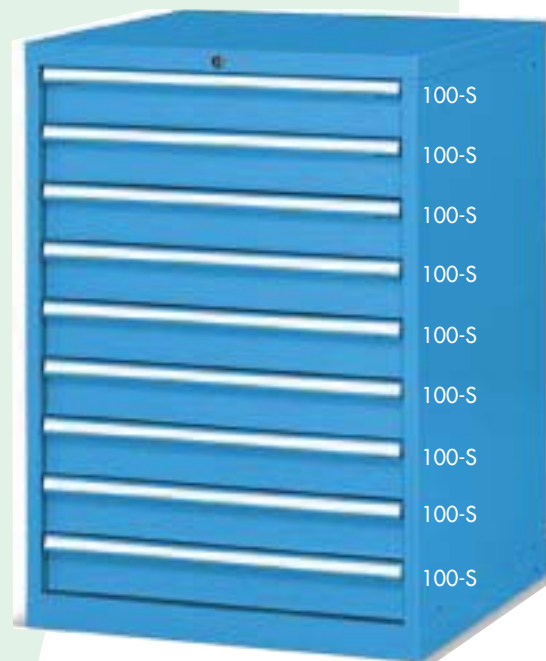

TECNO STANDARD 8

Art. J 14003 04

Ral 5012

Armadio con 8 cassetti **vuoti** e chiusura a cilindro con due chiavi. Dim. 717x726x1000 mm h.

TECNO STANDARD 9

Art. J 14007 04

Ral 5012

Armadio con 9 cassetti **vuoti** e chiusura a cilindro con due chiavi. Dim. 717x726x1000 mm h.

TECNO STANDARD SET 8 Art. J 14103 00

Set materiale di separazione per 7 cassetti composto da 2 divisori fessurati longitudinali e 3 divisori trasversali per ogni cassetto.



TECNO STANDARD SET 9 Art. J 14107 00

Set materiale di separazione per 9 cassetti composto da 2 divisori fessurati longitudinali e 3 divisori trasversali per ogni cassetto.



TECNO WORK 3

Art. J 14099 07

Piano 3 bordi con gomma antiolio per TECNO STANDAR.
Dim. 717x726x20 mm h.



S: Estrazione semplice



Cassetto h 50: 60 Kg
 Cassetto h 75: 80 Kg
 Cassetto h 100: 100 Kg
 Cassetto h 150: 100 Kg
 Cassetto h 200: 100 Kg

Capacità di carico statico dell'armadio
3000 Kg

CASSETTI DIM. 600x600 mm

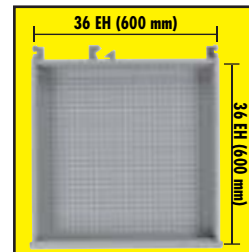

Safety-bar
 Apertura singola dei cassetti che **evita** il ribaltamento dell'armadio.
 Di serie su TECNO STANDARD.

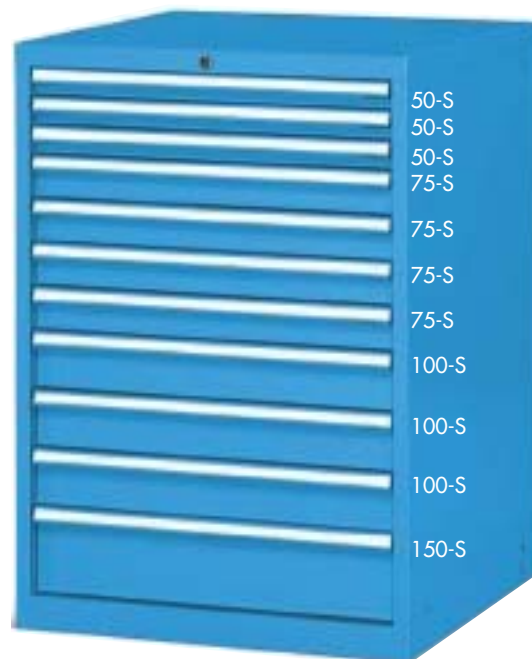

TECNO STANDARD 9.1
 Art. **J 14009 04** Ral 5012
 Armadio con 9 cassetti **vuoti** e chiusura a cilindro con due chiavi.
 Dim. 717x726x1000 mm h.

TECNO STANDARD 11
 Art. **J 14005 04** Ral 5012
 Armadio con 11 cassetti **vuoti** e chiusura a cilindro con due chiavi.
 Dim. 717x726x1000 mm h.

TECNO STANDARD SET 9.1 Art. **J 14109 00**
 Set materiale di separazione per 8 cassetti composto da 2 divisori fessurati longitudinali e 3 divisori trasversali per ogni cassetto.

X 8

TECNO STANDARD SET 11 Art. **J 14105 00**
 Set materiale di separazione per 11 cassetti composto da 2 divisori fessurati longitudinali e 3 divisori trasversali per ogni cassetto.

X 11

TECNO WORK 3
 Art. **J 14099 07**
 Piano 3 bordi con gomma antiolio per TECNO STANDART.
 Dim. 717x726x20 mm h.

TT: Estrazione totale telescopica



Cassetti:
200 Kg

Capacità di carico statico dell'armadio
3000 Kg

CASSETTI DIM. 600x600 mm

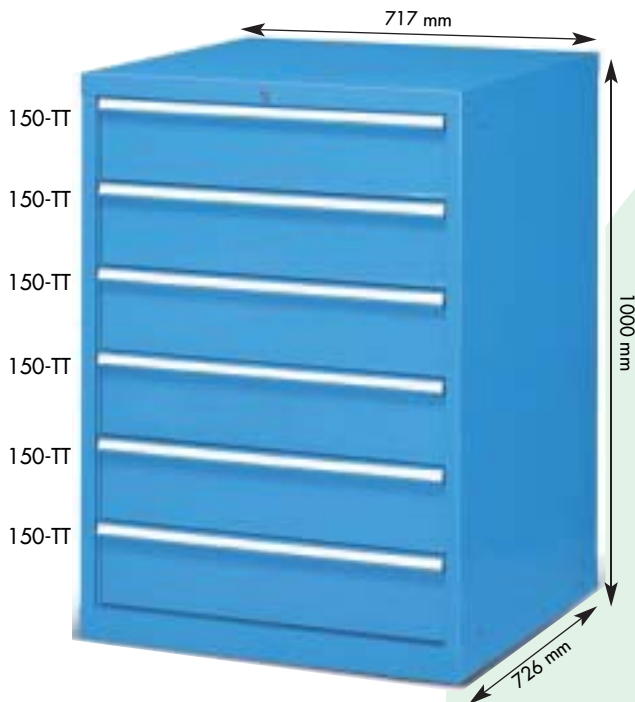
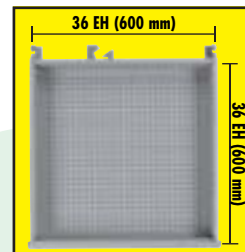

Safety-bar
Apertura singola dei cassetti che **evita** il ribaltamento dell'armadio.
Di serie su **TECNO STRONG**.

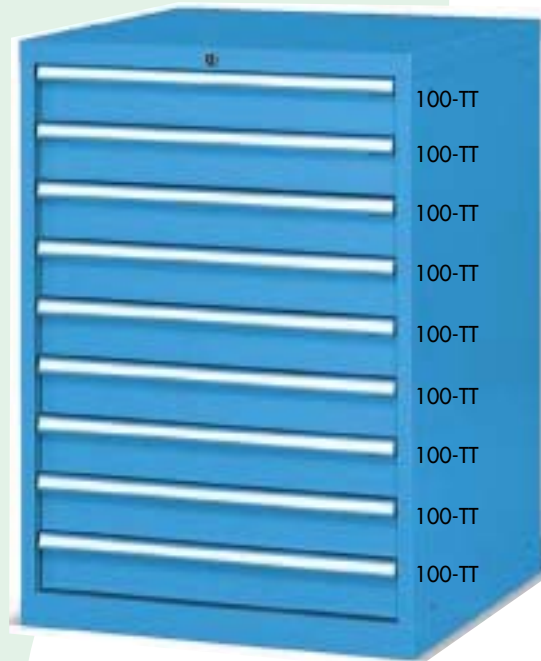

TECNO STRONG 6

Art. **J 14019 04**

Ral 5012

Armadio con 6 cassetti **vuoti** e chiusura a cilindro con due chiavi. Dim. 717x726x1000 mm h.

TECNO STRONG 9

Art. **J 14021 04**

Ral 5012

Armadio con 9 cassetti **vuoti** e chiusura a cilindro con due chiavi. Dim. 717x726x1000 mm h.

TECNO STRONG SET 6 Art. **J 14119 00**

Set materiale di separazione per 6 cassetti composto da 2 divisori fessurati longitudinali e 3 divisori trasversali per ogni cassetto.



X 6

TECNO STRONG SET 9 Art. **J 14121 00**

Set materiale di separazione per 9 cassetti composto da 2 divisori fessurati longitudinali e 3 divisori trasversali per ogni cassetto.



X 9



TECNO WORK 3

Art. **J 14099 07**

Piano 3 bordi con gomma antiscivolo per TECNO STRONG
Dim. 717x726x20 mm h.





TECNO AIR 30

Art. J 10002 04

Ral 5012

Armadio completo di: n. 4 piani profondità 500 mm.
Senza attrezzi. Dim. 1023x555x2000 mm h.

TECNO AIR 31

Art. J 10001 04

Ral 5012

Armadio completo di: n. 4 piani profondità 500 mm,
n. 3 cassetti ad estrazione semplice.
Senza attrezzi. Dim. 1023x555x2000 mm h.

Piano: 100 Kg
Cassetto: 50 Kg

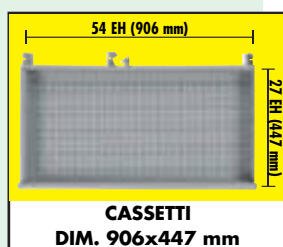

Misura 1

Dimensioni
160/140x95x75 mm h



Misura 2

Dimensioni
230/200x140x130 mm h



Obbligo di
fissaggio a
pavimento o a
parete
dell'armadio.



Misura 3A2

Dimensioni
350/300x200x145 mm h

TECNO AIR 32

Art. J 10010 04

Ral 5012

Armadio completo di: n. 4 piani profondità 250 mm (25Kg), n. 3 piani
profondità 345 mm (50Kg), n. 1 piano profondità 500 mm (100Kg),
n. 16 barre aggancio contenitori, n. 3 cassetti ad estrazione semplice
(50Kg), n. 40 contenitori blu mis. 1, n. 44 contenitori grigi mis. 2,
n. 16 contenitori blu mis. 3A2.

Senza attrezzi: Dim. 1023x555x2000 mm h.

Piano: 100 Kg
Cassetto: 50 Kg



Obbligo di
fissaggio a
pavimento o a
parete
dell'armadio.

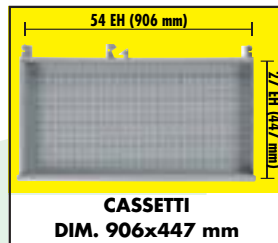

TECNO AIR 40

Art. J 10050 04

Ral 5012

Armadio completo di: n. 4 piani profondità 370 mm.
Senza attrezzi: Dim. 1500x450x2000 mm h.



TECNO AIR 50

Art. J 10051 04

Ral 5012

Armadio completo di: n. 4 piani profondità 500 mm.
Senza attrezzi: Dim. 1500x600x2000 mm h.



TECNO AIR 60

Art. J 10052 04

Ral 5012

Armadio completo di: n. 8 piani profondità 500 mm,
n. 6 cassette ad estrazione semplice, n. 1 divisorio centrale.
Senza attrezzi: Dim. 2046x600x2000 mm h.

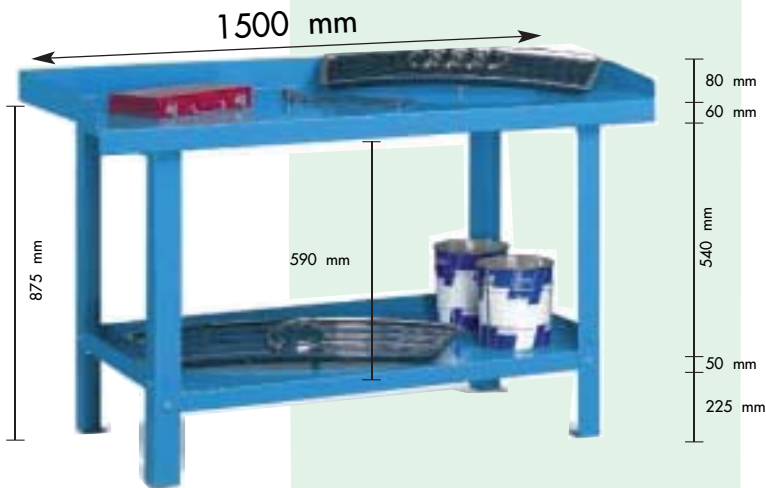

Dimensione piano inferiore:
ERGO STILL 150/155 1200x650x50 mm h
ERGO STILL 200/205 1700x650x50 mm h

ERGO STILL 150
 Art. **J 46017 04** Ral 5012
 Banco in acciaio. Dim. 1500x700x875 mm h.

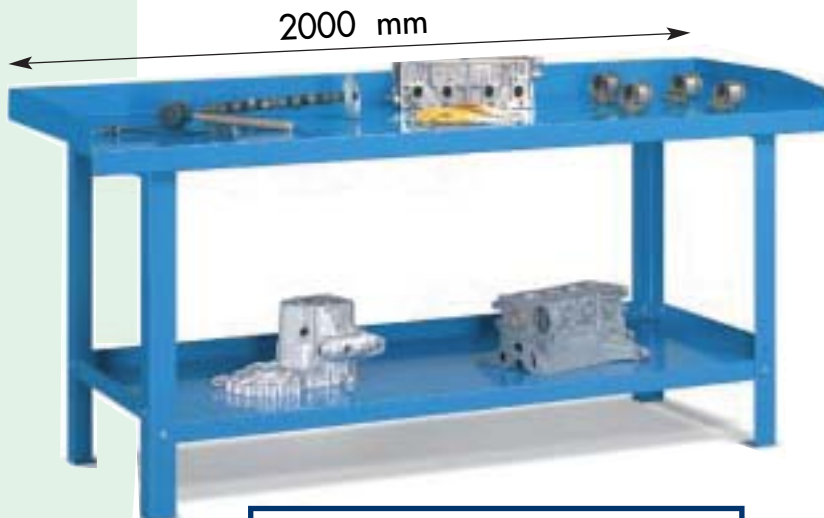

Cassetti con **CUSCINETTI A SFERA IN ACCIAIO**.

 Cassetto: 50 Kg

ERGO STILL 50
 Art. **J 46019 04** Ral 5012
 Cassetto in acciaio con cuscinetti a sfera
 Dim. 452x567x155 mm h.

ERGO STILL 200
 Art. **J 46018 04** Ral 5012
 Banco in acciaio. Dim. 2000x700x875 mm h.

Lunghezza 1500 mm
 Ral 5012

Lunghezza 1500 mm
 Ral 5012

ERGO STILL 151 Composto da:
 Art. **J 46023 04** n. 1 ERGO STILL 150
 n. 1 ERGO STILL 50

ERGO STILL 152 Composto da:
 Art. **J 46024 04** n. 1 ERGO STILL 150
 n. 2 ERGO STILL 50

Lunghezza 2000 mm
 Ral 5012

Lunghezza 2000 mm
 Ral 5012

Lunghezza 2000 mm
 Ral 5012

ERGO STILL 201 Composto da:
 Art. **J 46020 04** n. 1 ERGO STILL 200
 n. 1 ERGO STILL 50

ERGO STILL 202 Composto da:
 Art. **J 46021 04** n. 1 ERGO STILL 200
 n. 2 ERGO STILL 50

ERGO STILL 203 Composto da:
 Art. **J 46022 04** n. 1 ERGO STILL 200
 n. 3 ERGO STILL 50

A Banco da lavoro con cassetiera a 3 cassetti.
Dim. 2000x750x880h mm.

verde
Ral 6011

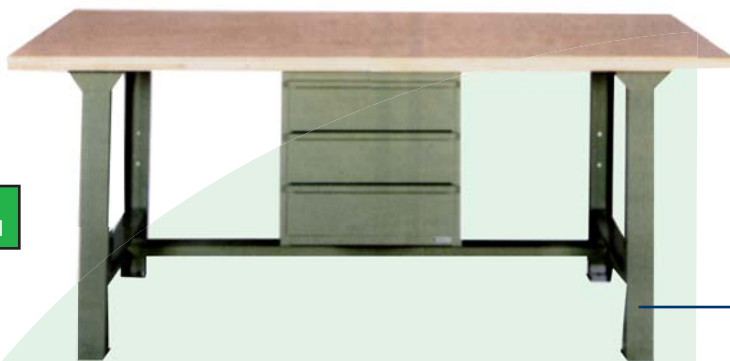

B Banco da lavoro con 1 cassetto e cassetiera a 3 cassetti.
Dim. 2500x750x880h mm.

verde
Ral 6011



C Banco da lavoro in ferro, piano sup. in multistrato
h 3 cm, piano inf. zincato due ruote fisse e maniglia
Dim. 1000x750x850h mm.

verde
Ral 6011



verde
Ral 6011

Dim. 1500x750x40h mm
Dim. 2000x750x40h mm.
Dim. 2500x750x40h mm.

Le gambe sono realizzate in lamiera di acciaio con fori sulla parte superiore per il fissaggio del pianale. I pianali in multistrato faggio, possono essere forniti in diverse dimensioni ed altezze.

esempi di diverse combinazioni



Figura A



Figura B

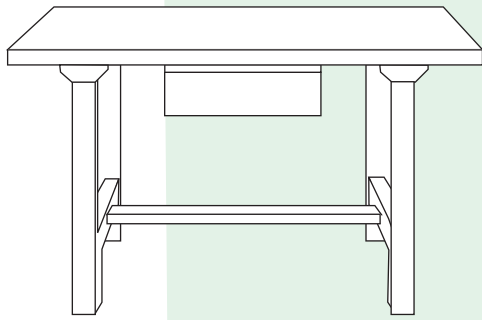

Figura C

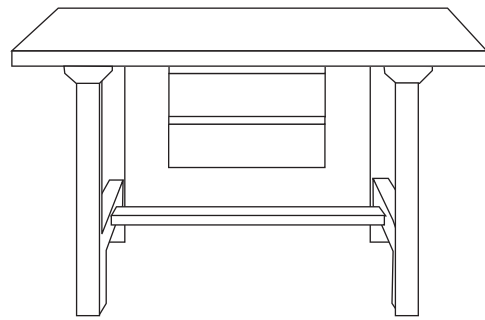

Figura D

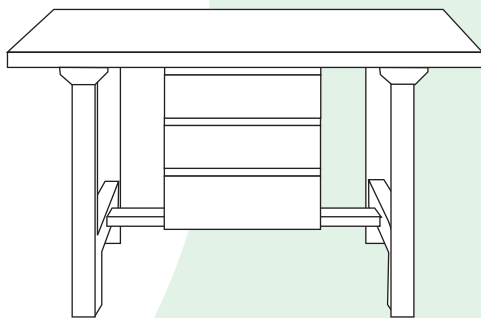

Figura E

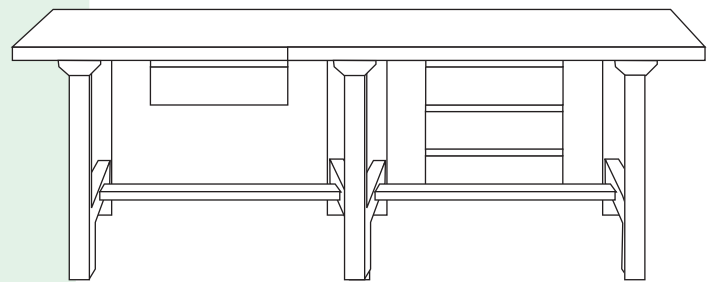

Figura F

**A**

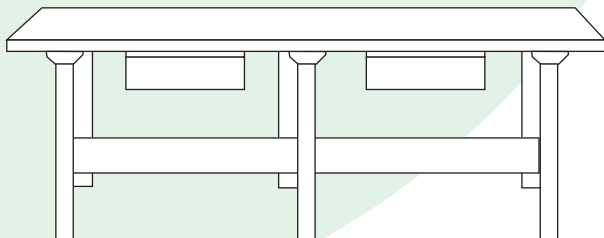
1 cassetto da banco, montato su cuscinetti a sfera applicabile sui banchi da lavoro.

Dim. 500x570x190h mm.

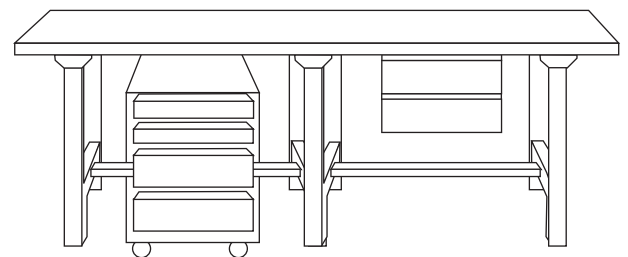
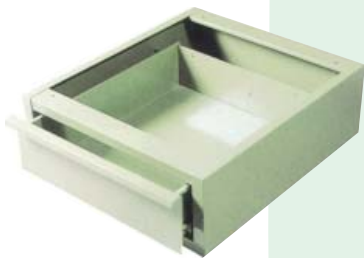
verde
Ral 6011

**B**

2 cassetti da banco, montati su cuscinetti a sfera applicabili sui banchi da lavoro.

Dim. 500x570x340h mm.

verde
Ral 6011

**C**

3 cassetti da banco, montati su cuscinetti a sfera applicabili sui banchi da lavoro.

Dim. 500x570x480h mm.

verde
Ral 6011

**A**

Carrello cassetiera portata 210 kg, **5 cassetti** portata cassetti 23 kg, 2 ruote girevoli e 2 fisse in nylon Ø 100 mm, piano in gomma.

Dim. 575x785x885h mm.

verde
Ral 6011

**B**

Carrello cassetiera portata 270 kg, **3 cassetti** portata cassetti 16 kg, 2 ruote girevoli e 2 fisse in nylon Ø 100 mm, piano in gomma.

Dim. 575x785x790h mm.

verde
Ral 6011

La portata dei cassetti è stata calcolata rispettando le norme di sicurezza sul ribaltamento del carrello. Per **evitare** il ribaltamento del banco, è **vietato** tenere aperto più di un cassetto per volta.



Piano: 50 Kg



Misura 1
Dimensioni
160/140x95x75 mm h



Misura 2
Dimensioni
230/200x140x130 mm h



Misura 3
Dimensioni
350/300x200x200 mm h

TECNO CAST 10

Art. J 18001 04

Ral 5012

Armadio completo di: n. 15 piani profondità 235 mm,
n. 16 fermi per contenitori, n. 96 contenitori blu mis. 1.
Dim. 700x270x1655 mm h.

TECNO CAST 11

Art. J 18008 04

Ral 5012

Armadio completo di: n. 9 piani profondità 235 mm,
n. 40 contenitori grigi mis. 2.
Dim. 700x270x1655 mm h.



Piano: 50 Kg



Portata carrelli
300 Kg



Portata barra
porta
contenitori
25 Kg

I carrelli vengono
forniti di serie con
2 ruote girevoli con
freno e 2 ruote fisse in
gomma Ø 125.



TECNO CAST 20

Art. J 18002 04

Ral 5012

Armadio completo di: n. 15 piani profondità 235 mm,
n. 16 fermi per contenitori, n. 96 contenitori blu mis. 1.
Dim. 700x270x1655 mm h.

TECNO CAST 90

Art. J 61002 04

Ral 5012

Carrello completo di: n. 12 barre complete di clips,
n. 36 contenitori blu mis. 1, n. 16 contenitori grigi mis. 2,
n. 12 contenitori grigi mis. 3. Dim. 805x760x1395 mm h.



PLAST BOX 1

Art. J 01001 01

Grigio

Contentore in plastica **mis. 1** in confezione da **50 pezzi**. Dim. 140/160x95x75 mm h.



PLAST BOX 2

Art. J 01002 01

Grigio

Contentore in plastica **mis. 2** in confezione da **54 pezzi**. Dim. 230/200x140x130 mm h.



PLAST BOX 3A2

Art. J 01003 01

Grigio

Contentore in plastica **mis. 3A2** in confezione da **21 pezzi**. Dim. 350/300x200x145 mm h.



PLAST BOX 3

Art. J 01004 01

Grigio

Contentore in plastica **mis. 3** in confezione da **15 pezzi**. Dim. 350/300x200x200 mm h.



PLAST BOX 4

Art. J 01005 01

Grigio

Contentore in plastica **mis. 4** in confezione da **10 pezzi**. Dim. 500/450x300x200 mm h.



METAL BOX 3C

Art. J 00001 01

Ral 7000

Cassetta in acciaio **mis. 272-3** in confezione da **10 pezzi**.
Dim. 300x200x200 mm h.



METAL BOX 3

Art. J 00002 01

Ral 7000

Cassetta in acciaio **mis. 3** in confezione da **10 pezzi**.
Dim. 350/300x200x200 mm h.



METAL BOX 4

Art. J 00003 01

Ral 7000

Contentore in acciaio **mis. 4** in confezione da **10 pezzi**.
Dim. 500/450x300x200 mm h..



METAL BOX 4C

Art. J 00004 01

Ral 7000

Cassetta in acciaio **mis. 272-4** in confezione da **10 pezzi**.
Dim. 450x300x200 mm h.



METAL BOX 5

Art. J 00005 01

Ral 7000

Contentore in acciaio **mis. 5** in confezione da **5 pezzi**.
Dim. 700/630x450x300 mm h.



A

Carrello a ripiani con ruote girevoli.
Dim. 810x800x400h mm.

Zincato



Art. 041 INOX

2 ruote in gomma antitraccia girevoli Ø 125
 2 ruote girevoli con freno o fisse Ø 125
 Dim. 600x1030x830h mm
 Peso 25 kg
 Portata 300 kg



Carrello 2 piani lisci



Art. 041 INOX

2 ruote in gomma antitraccia girevoli Ø 125
 2 ruote girevoli con freno o fisse Ø 125
 Dim. 600x1030x830h mm
 Peso 25 kg
 Portata 300 kg



Carrello 2 piani lisci

Art. 041V INOX

2 ruote in gomma antitraccia girevoli Ø 125
 2 ruote girevoli con freno o fisse Ø 125
 Dim. 600x1030x830h mm
 Peso 25 kg
 Portata 300 kg



Carrello 2 piani con bordo di contenimento



Art. 041AV INOX

2 ruote in gomma antitraccia girevoli Ø 125
 2 ruote girevoli con freno o fisse Ø 125
 Dim. 500x930x830h mm
 Peso 17 kg
 Portata 300 kg



Carrello 2 piani con bordo di contenimento

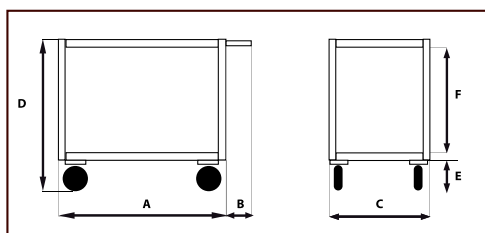

OPTIONAL PARACOLPI



art.	A	B	C	D	E	F	G
Art. 041 INOX	900	130	600	870	175	630	
Art. 041A INOX	800	130	500	850	160	630	
Art. 041V INOX	900	130	600	880	200	630	
Art. 041AV INOX	800	130	500	880	190	630	



Art. 040 INOX

2 ruote in gomma antitraccia girevoli Ø 125
 2 ruote girevoli con freno o fisse Ø 125
 Dim. 600x1030x830h mm
 Peso 35 kg
 Portata 300 kg



Carrello di servizio a 3 piani con bordo di contenimento in acciaio alimentare AISI 304



Art. 040A INOX

2 ruote in gomma antitraccia girevoli Ø 125
 2 ruote girevoli con freno o fisse Ø 125
 Dim. 500x930x830h mm
 Peso 27 kg
 Portata 250 kg



Carrello di servizio a 3 piani con bordo di contenimento in acciaio alimentare AISI 304

Art. 042 INOX

2 ruote in gomma antitraccia girevoli Ø 125
 2 ruote girevoli con freno o fisse Ø 125
 Dim. 500x800x900h mm
 Peso 18 kg
 Portata 300 kg



Carrello a pianale in acciaio alimentare AISI 04



Art. 042A INOX

2 ruote in gomma antitraccia girevoli Ø 125
 2 ruote girevoli con freno o fisse Ø 125
 Dim. 600x900x900h mm
 Peso 20 kg
 Portata 300 kg



Carrello a pianale in acciaio alimentare AISI 04

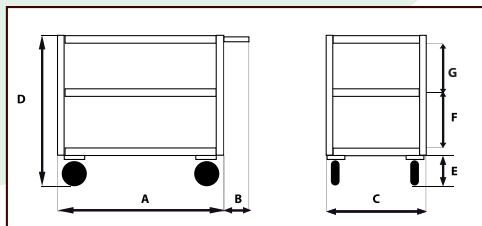

OPTIONAL PARACOLPI



art.	A	B	C	D	E	F	G
Art. 040 INOX	900	130	600	895	200	300	300
Art. 040A INOX	800	130	500	880	185	300	300

Art. 043 INOX

2 ruote girevoli in gomma piena Ø 125
2 ruote girevoli fisse Ø 125
Dim. 500x1000x830h / 1300x850h mm
Peso 16 kg
Portata 350 kg



**Carrello a pianale allungabile in acciaio alimentare
AISI 304**



Art. 044A INOX

2 ruote pneumatiche girevoli Ø 260
2 ruote pneumatiche fisse o girevoli Ø 125
Dim. 800x1230x1100h mm
Peso 35 kg
Portata 350 kg



**Carrello a pianale in acciaio alimentare
AISI 304**



Art. 044 INOX

2 ruote fisse Ø 200
Dim. 410x610x935h mm
Peso 30 kg
Portata 500 kg



**Carrello a pianale in acciaio alimentare
AISI 304**





Art. **073.8450**
Art. **073.10450**



4 ruote in gomma girevoli Ø 100
Dim. **art. 073.8450** 500x840x930h mm
Dim. **art. 073.10450** 500x1047x930h mm
Peso 12 kg
Portata 200 kg

Carrello di servizio a 2 ripiani in acciaio



Art. **074.8450**
Art. **074.10450**



4 ruote in gomma girevoli Ø 100
Dim. **art. 074.8450** 500x840x930h mm
Dim. **art. 074.10450** 500x1047x930h mm
Peso 12 kg
PARACOLPI ANTIROMBO

Carrello di servizio a 3 ripiani in acciaio

Art. **073NB**



4 ruote in nylon girevoli Ø 100
Dim. 410x610x935h mm
Peso 9,2 kg
Portata 100 kg

Carrello di servizio a 2 ripiani in acciaio inox



Art. **074NB**



4 ruote in nylon girevoli Ø 100
Dim. 410x610x935h mm
Peso 11,2 kg
Portata 100 kg

Carrello di servizio a 3 ripiani in acciaio inox





I carrelli sono
forniti di serie
con ruote
in gomma



**Portata
carrello
300 Kg**



**Portata
piano
100 Kg**

TECNO SERVICE 4

Art. **J 62012 04**

Ral 5012

Carrello con 2 ruote girevoli e 2 ruote fisse Ø 100 mm.
Confezione da 3 pezzi. Dim. 875x545x840 mm h.

TECNO SERVICE 5

Art. **J 62013 04**

Ral 5012

Carrello con 2 ruote girevoli e 2 ruote fisse Ø 100 mm.
Confezione da 3 pezzi. Dim. 875x545x840 mm h.



**Portata
carrello
300 Kg**



**Portata
piano
100 Kg**



TECNO SERVICE 6

Art. **J 62014 04**

Ral 5012

Carrello con 2 ruote girevoli e 2 ruote fisse Ø 125 mm.
Confezione da 3 pezzi. Dim. 1100x660x870 mm h.

TECNO SERVICE 1

Art. **J 62015 04**

Ral 5012

Carrello con 2 ruote girevoli e 2 ruote fisse Ø 125 mm.
Confezione da 3 pezzi. Dim. 1100x660x870 mm h.

TECNO SERVICE 1

Art. **J 62017 04**

Ral 5012

Carrello con 2 ruote girevoli e 2 ruote fisse Ø 125 mm.
Confezione da 3 pezzi. Dim. 1135x700x915 mm h.



**Portata
250 Kg**



TECNO 420

Art. J 57001 99

Zincato

Campata base con crociera e 5 piani.
Dim. 1080x400x2000 mm h



TECNO 421

Art. J 57002 99

Zincato

Campata base con 5 piani.
Dim. 1020x400x2000 mm h



TECNO 422

Art. J 57003 99

Zincato

Campata base con crociera e 5 piani.
Dim. 1020x400x2000 mm h



TECNO 520

Art. J 57004 99

Zincato

Campata base con crociera e 5 piani.
Dim. 1080x500x2000 mm h



TECNO 521

Art. J 57005 99

Zincato

Campata base con 5 piani.
Dim. 1020x500x2000 mm h



TECNO 522

Art. J 57006 99

Zincato

Campata base con crociera e 5 piani.
Dim. 1020x500x2000 mm h



SISTEMA A BULLONI

Scaffalature a bullone

piantana 2000/2500 mm.

Baccinella per scaffale
400

ripiano 900x400 mm.
ripiano 900x500 mm.

Zincato



La **Errebi s.n.c.** opera da più di

trent'anni nel settore della

CARPENTERIA LEGGERA DI PRECISIONE

e **ARREDAMENTI INDUSTRIALI.**

L'Azienda dispone di macchinari

tecnologicamente avanzati con

grandi capacità produttive in grado

di offrire un prodotto finito,

garantendo qualità, precisione, velocità

di esecuzione con un'affidata tecnica.

L'immobile che ospita la nostra

azienda si estende su 2000 mq,

suddivisi in diversi reparti di lavorazione.

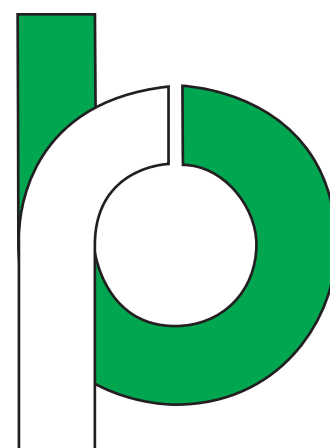

errebi

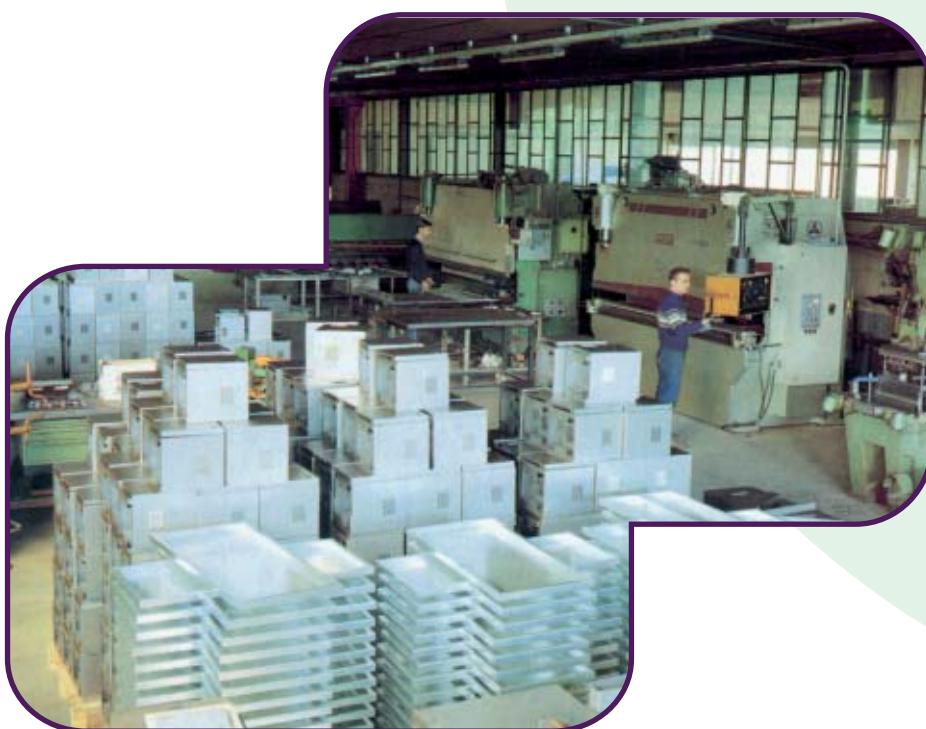

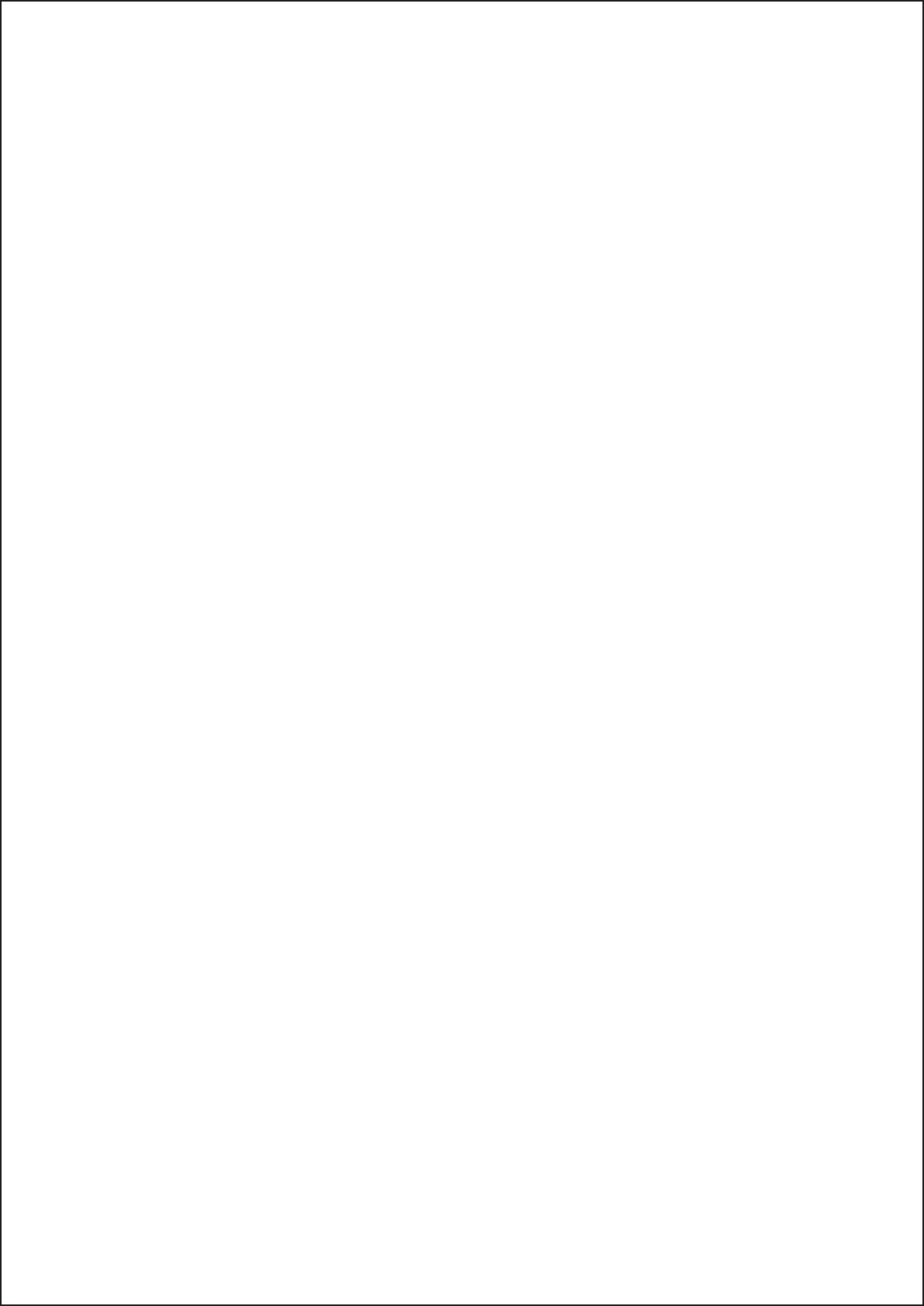

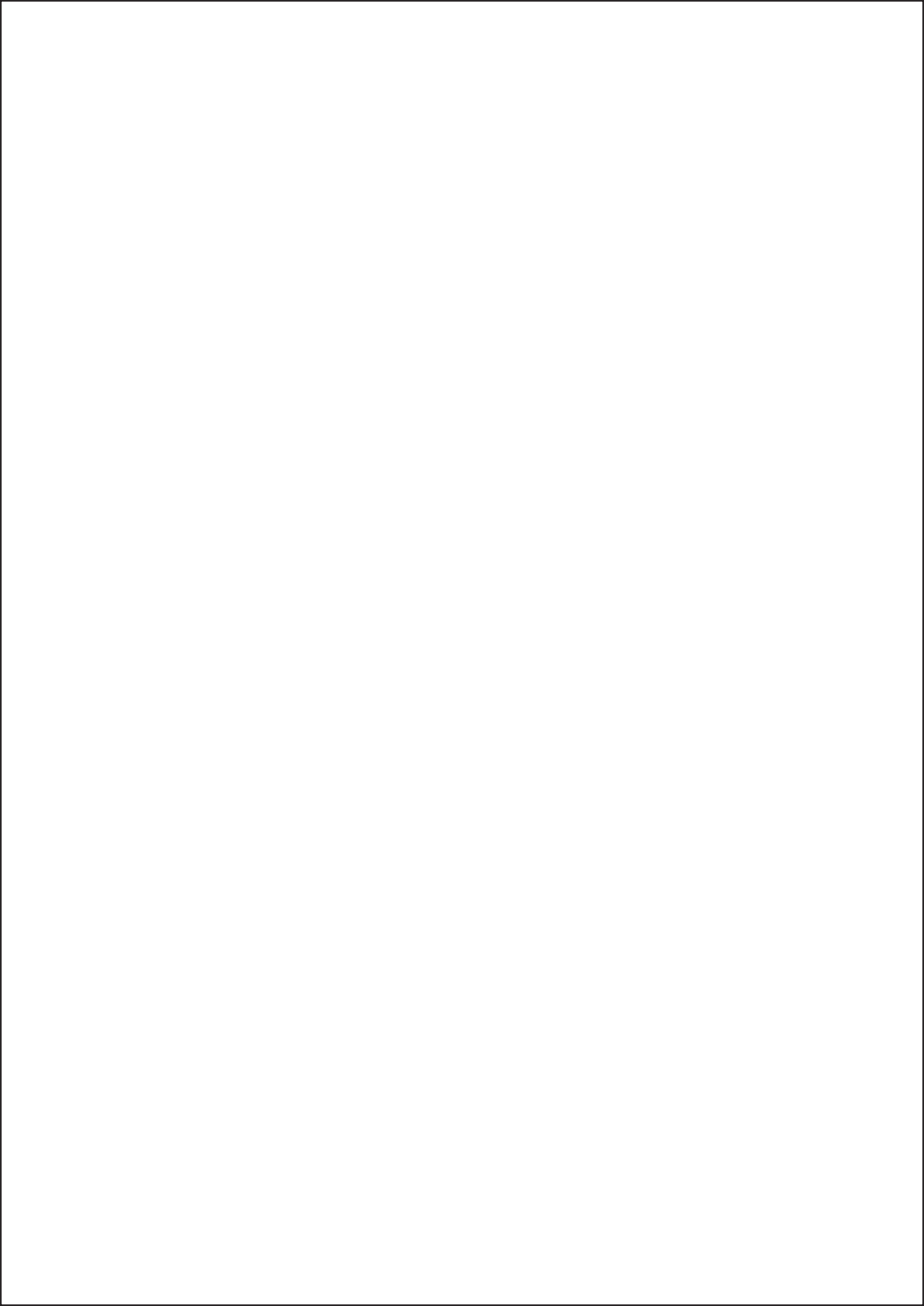

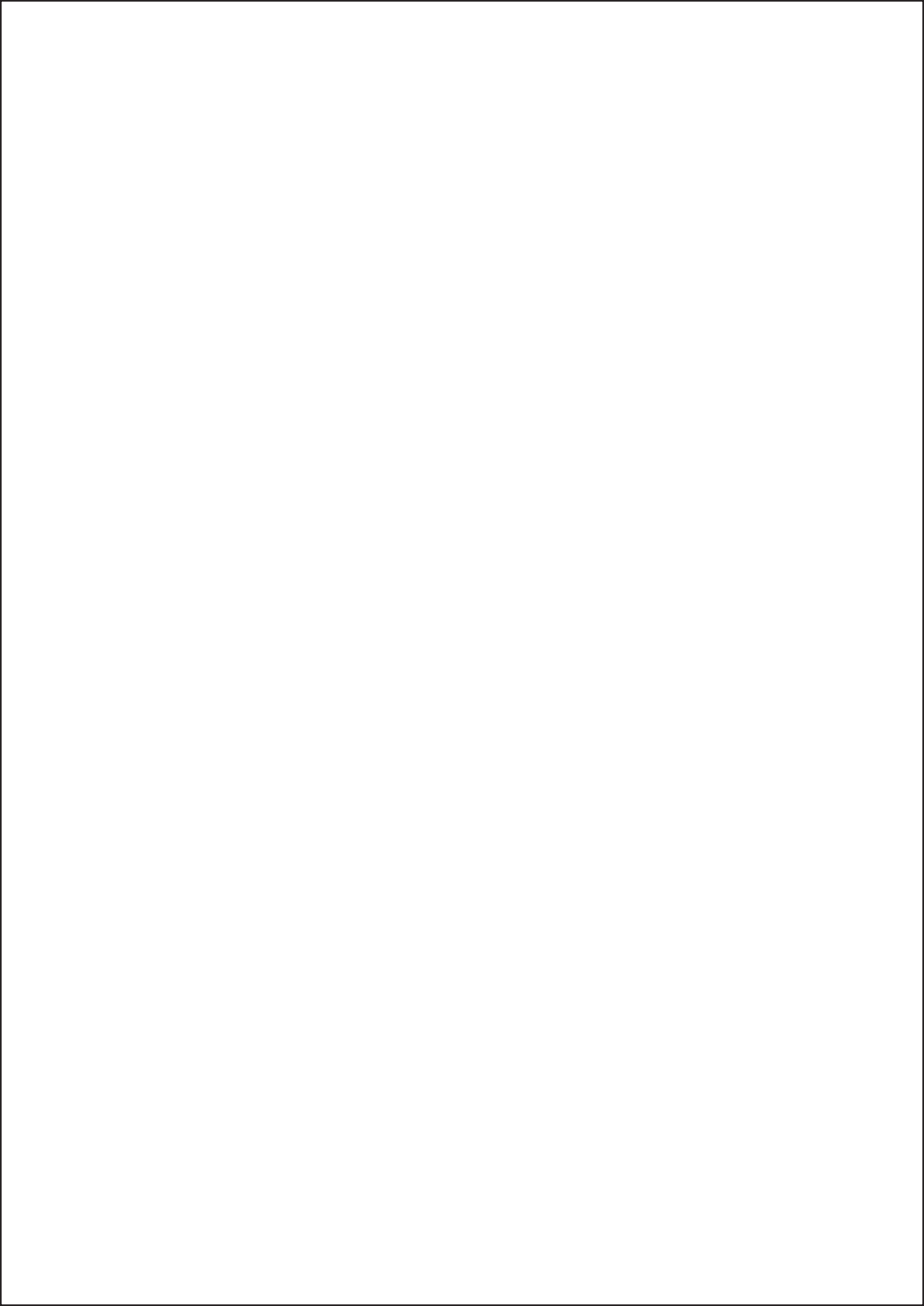

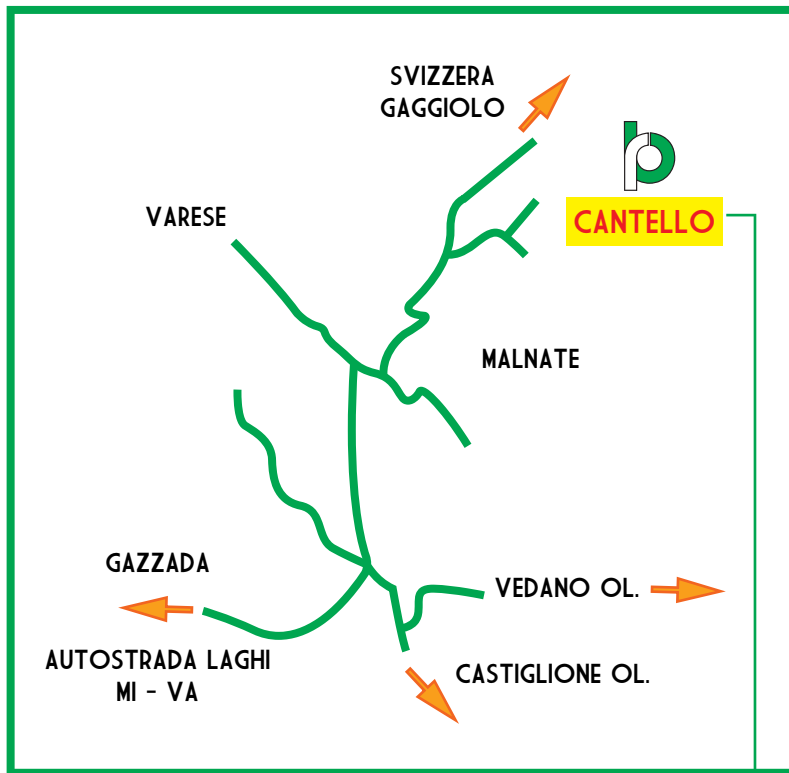

errebi

RINALDO BUZZI SAS DI BUZZI FULVIA & C.

Via Pianezzo, 40 - 21050 Cantello (VA)

E-mail: info@errebiva.it

Tel. +39 0332.417854 - Fax: +39 0332.417831

Cod.Fisc. - P.Iva 00798700126

